

EFEN 

TPS

Fault Terminator

600 A

Telecom Power Supply Products

Produkte für Telekom Stromversorgung

Block diagram of telecom power supply
Schematische Darstellung einer Telekom Stromversorgung

AC See catalogue NT-IN
Siehe Katalog NT-IN

TPS

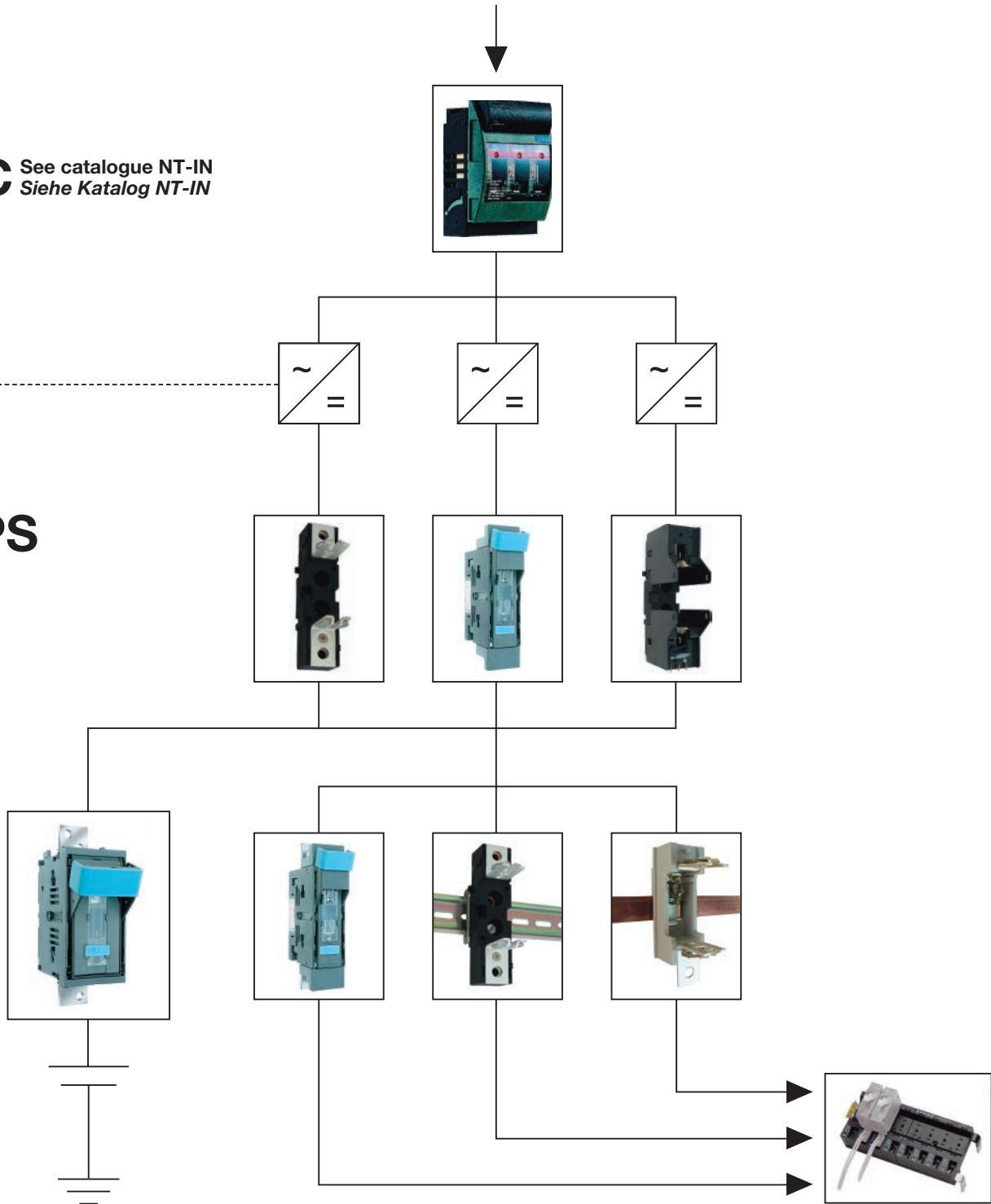



This diagram shows applications of EFEN products in a typical telecom power supply with AC feed-in, protection of rectifier, battery protection, DC-distribution in power supply as well as following system.

EFEN products are governed by a strict quality control. Engineering progress is a continuous process to us. Any information and data may therefore be changed without prior notification.











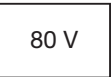

Die Darstellung zeigt die Einsatzmöglichkeiten der EFEN Produkte einer typischen Telekom Stromversorgung mit AC-Einspeisung, Absicherung der Gleichrichter, Batterieabsicherung, DC-Verteilungen in der Stromversorgung sowie der nachfolgenden Einheit.

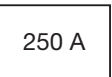
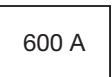
EFEN Produkte unterliegen strengen Qualitätsüberprüfungen. Technische Fortschritte sind für uns ein permanenter Prozeß. Alle genannten Angaben und Daten können daher ohne Ankündigung geändert werden.

	Content	Page	Inhalt	Seite
	1 Fuse-Links, Fuse-Isolators, Fuse-Bases application	4	1 Sicherungen, Sicherungs-Trenner, Sicherungs-Unterteile Anwendung	4
	1.1 Fuse-Links	5	1.1 Sicherungen	5
	1.2 Fuse-Isolators	7	1.2 Sicherungs-Trenner	7
	1.3 Fuse-Bases	10	1.3 Sicherungs-Unterteile	10
	2. Supply bus modules application	12	2 Stromverteilermodule Anwendung	12
	2.1 Supply bus modules	12	2.1 Stromverteilermodule	12
	3 Drawings	13	3 Maßbilder	13

Symbol explanation

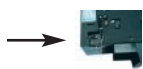
Zeichen Erklärungen

	AC	Alternating current		Wechselspannung
	DC	Direct current		Gleichspannung
	80 V	Rated operational voltage 80 V		Bemessungsbetriebsspannung 80 V
	690 V	Rated operational voltage 690 V		Bemessungsbetriebsspannung 690 V
	250 A	Rated operational current 250 A		Bemessungsbetriebsstrom 250 A
	600 A	Rated operational current 600 A		Bemessungsbetriebsstrom 600 A
	1.600 A	Rated operational current 1.600 A		Bemessungsbetriebsstrom 1.600 A
		Busbar mounting by screw		Sammelschienenmontage mit Schraube
		Busbar mounting by contact hook (accessory)		Sammelschienenmontage mit Haken (Zubehör)
		Fuse monitoring (optional), monitor if fuse has blown		Sicherungsüberwachung (optional), Überwachung, ob Sicherung abgeschaltet hat
		Switch position indication of lid; "open" or "close" with micro switch (accessory)		Schaltstellungsanzeige des Deckels; „open“ oder „geschlossen“ mit Mikroschalter (Zubehör)
		Approval: UL recognition		Zulassung: UL recognition

Fuse-Links – Isolators – Fuse-Bases

1 Application

TPS series is specifically designed for short circuit protection of DC telecom power supplies. It is typically installed in rectifier outputs, battery feeders or DC power distribution for protection of the load circuits.

The application can be protection and isolation of battery as well as DC powered circuit protection.

Advantages of these new designed product line are high flexibility and very compact housing.

Sicherungen – Trenner – Unterteile

1 Anwendung

Die TPS-Reihe ist speziell entwickelt für den Kurzschlusschutz in DC Telekom Stromversorgungen. Sie wird eingesetzt in den Ausgängen von Gleichrichtern, Batterieeinspeisungen oder zur Absicherung der Verbraucher in Verteilungen.

Einsatzfelder sind sowohl der Schutz und die Trennung der Batterie als auch der Schutz von DC Stromkreisen.

Die Vorteile dieser neu entwickelten Produktreihe liegen in der hohen Flexibilität und den außerordentlich kompakten Abmessungen.

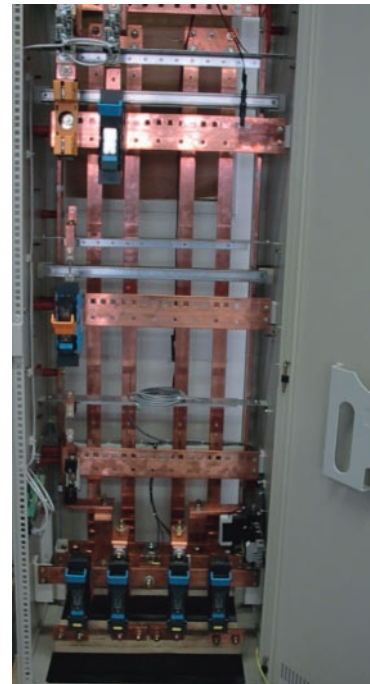
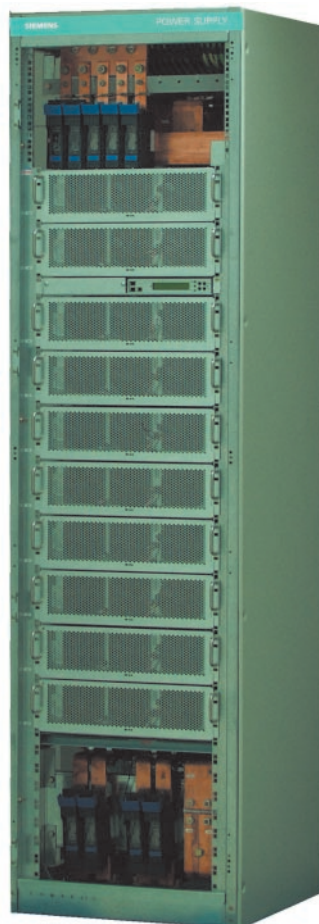
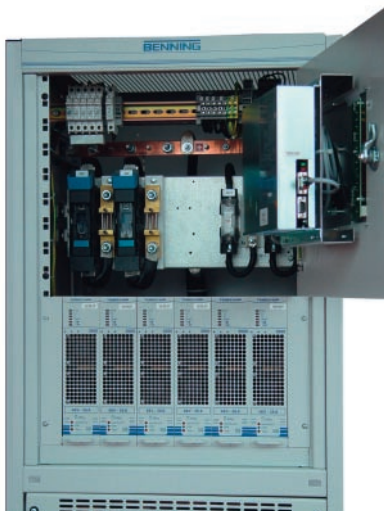

TPS 00

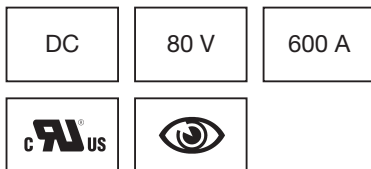
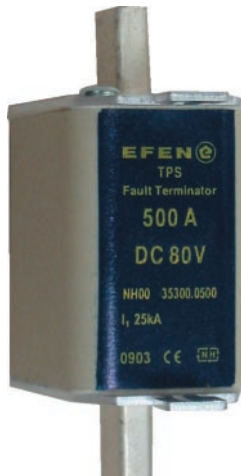

Product description

1.1 TPS Fault Terminator Fuse-Links

Fault Terminators characteristic is optimized to suit the operating conditions of telecom power supply equipment and provides best function and protection of telecom power supplies:

- Low voltage drop
- Low power dissipation
- Low switching voltage

Furthermore Fault Terminator is significant for:

- High current limitation
- Age-resistant pure silver melting element.

Produktbeschreibungen

1.1 TPS Fault Terminator Sicherungen

Die Charakteristik des Fault Terminators ist ausgelegt auf die Arbeitsbedingungen von Telekom Einrichtungen und gewährleistet die beste und sicherste Funktion der Telekom Stromversorgung:

- Geringer Spannungsfall
- Geringe Leistungsabgabe
- Geringe Schaltspannung

Weiterhin kennzeichnet den Fault Terminator:

- Strombegrenzung
- Alterungsbeständigkeit des Silberschmelzleiters.

TPS 2

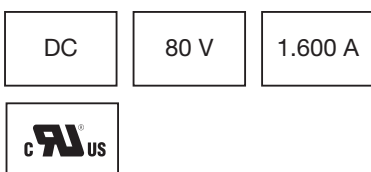

The design is very compact for minimum space requirements of the system. The colour of the Fuse-Links prevents mixing up with other fuse types.

The TPS Fault Terminator is used in combination with corresponding EFEN TPS Fuse-Isolators or Fuse-Bases.

Die sehr kleinen Abmessungen bieten eine optimale Baugröße für die geringen Abmessungen der Stromversorgungsanlage. Die Sicherungsfarbe verhindert Verwechselungen mit anderen Sicherungseinheiten.

Eingesetzt wird der Fault Terminator in EFEN TPS Sicherungs-Trennern oder Sicherungs-Unterteilen.

Rated Current	Size	Rated Power Dissipation	Order-No. Standard	Order-No. With striker	Pack
<i>Nennstrom (DC) A</i>	<i>Größe NH</i>	<i>Leistungsabgabe W</i>	<i>Bestell-Nr. Standard</i>	<i>Bestell-Nr. Mit Signalmelder</i>	<i>VE</i>
60	00	4,5	35300.0060	35301.0060	3
80	00	5	35300.0080	35301.0080	3
100	00	6,5	35300.0100	35301.0100	3
150	00	10	35300.0150	35301.0150	3
200	00	12	35300.0200	35301.0200	3
250	00	13	35300.0250	35301.0250	3
300	00	16	35300.0300	35301.0300	3
400	00	19,5	35300.0400	35301.0400	3
500	00	26	35300.0500	35301.0500	3
600	00	29	35300.0600	35301.0600	3
800	2	43	35330.0800	—*	1
1.000	2	57	35330.1000	—*	1
1.200	2	64	35330.1200	—*	1
1.600	2	95	35330.1600	—*	1

* Fuse monitoring in the lid of Fuse-Isolator (see page 8)/Sicherungsüberwachung im Deckel des Sicherungs-Trenners (siehe Seite 8)

Explanation

TPS Fault Terminators Fuse-Links with striker are used for fuse monitoring. After operation of the fuse the striker pin releases and operates a micro switch. The micro-switch is inside the TPS Fuse-Isolator in version "Fuse-monitoring". This is available in size 00 (see page 7 and 8).

In size 2 there is an additional striker inside the lid of the TPS Fuse-Isolator that will operate the micro switch after the Fuse-Links has blown. This makes it possible to use standard Fuse-Links also for types with fuse monitoring (see page 8).

Erklärung

TPS Fault Terminator Sicherungen mit Signalmelder dienen zur Sicherungsüberwachung. Nach Abschalten der Sicherung tritt der Signalmelder hervor, der über einen Mikroschalter zur Auswertung kommt. Der Mikroschalter befindet sich im TPS Sicherungs-Trenner in der Ausführung mit „Sicherungs-Überwachung“. Erhältlich ist dies in der Baugröße 00 (siehe Seite 7 und 8).

Bei der Baugröße 2 befindet sich ein zusätzlicher Signalmelder im Deckel des TPS Sicherungs-Trenners, der nach Abschaltung der Sicherung den Mikroschalter betätigt. Dies ermöglicht die Verwendung einer Standard Sicherung auch für die Ausführung mit Sicherungsüberwachung (siehe Seite 8).

1.2 TPS Fuse-Isolator

EFEN TPS Fuse-Isolators are specifically designed for telecom power supplies. Equipped with EFEN-TPS Fault Terminators (specifically designed NH Fuse-Link; see page 5) they protect and disconnect power supply circuits up to 1.600 A operating currents.

Advantages of TPS Fuse-Isolators are:

- **Space-saving:** very compact design
- **Economical:** by high flexibility only small store-keeping necessary
- **Safe:** operation and electric shock protected

Types

TPS 00/250

=> Base plate mounting
see product photo (left)

=> Busbar mounting
– Screw

1.2 TPS Sicherungs-Trenner

EFEN TPS Sicherungs-Trenner sind speziell entwickelt für die Anwendung in Telekom Stromversorgungen. In Kombination mit EFEN-TPS Fault Terminator (speziell entwickelter Sicherungseinsatz; siehe Seite 5) dienen sie als Absicherungseinheit bis 1.600 A.

Vorteile der TPS Sicherungs-Trenner sind:

- **Platzsparend:** sehr kompakte Bauform
- **Wirtschaftlich:** durch hohe Flexibilität nur geringe Lagerhaltung
- **Sicher:** berührungsgeschützt bei hoher Bediensicherheit

Ausführungen

TPS 00/250

=> Aufbaumontage
siehe Produktfoto (links)

=> Sammelschienenmontage
– Schraube

TPS 00/250



DC	80 V	250 A

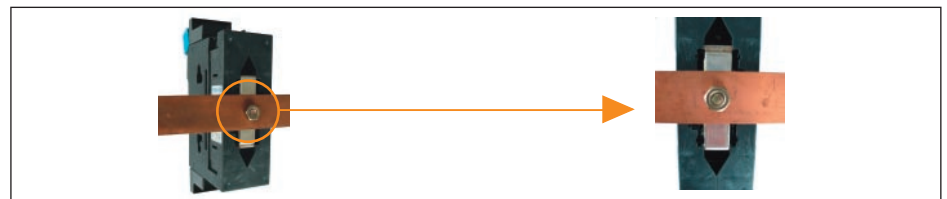

– Contact hook

– Haken

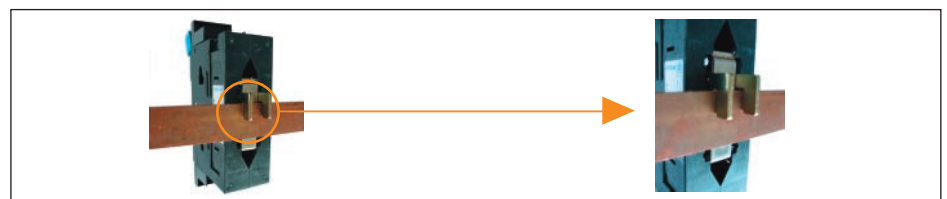

=> Fuse monitoring

=> Sicherungs-Überwachung



TPS 00/600



DC	80 V	600 A

TPS 00/600

=> Base plate mounting
see product photo (left)

=> Busbar mounting
- Screw

TPS 00/600

=> Aufbaumontage
siehe Produktfoto (links)

=> Sammelschienenmontage
- Schraube

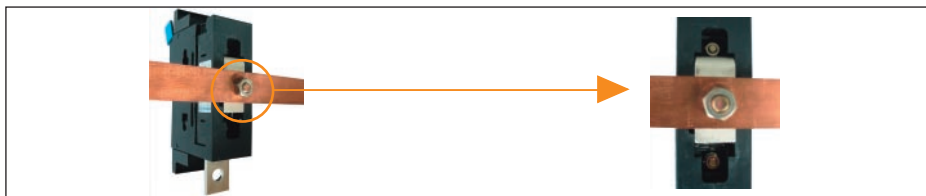

- Contact hook

- Haken

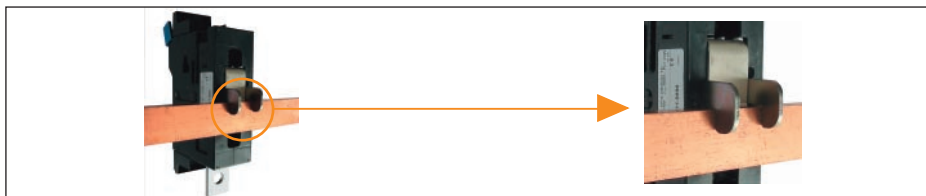

=> Fuse monitoring

=> Sicherungs-Überwachung



TPS 2/1.200-1.600



DC	80 V	1600 A

TPS 2/1.200-1.600

=> Base plate mounting
see product photo (left)

=> Fuse monitoring

TPS 2/1.200-1.600

=> Aufbaumontage
siehe Produktfoto (links)

=> Sicherungs-Überwachung







Technical data/Technische Daten

Rated operational voltage <i>Bemessungsbetriebsspannung</i>	DC 80 V	Permissible ambient air temperature <i>Zulässige Umgebungstemperatur</i>	-40 up to/bis +55 °C
--	---------	---	----------------------



Type	Terminals	TPS Fault Terminator	Order-No. Standard	Order-No. With fuse monitoring	Torque Housing	Torque Terminals	Pack
<i>Ausführung</i>	<i>Anschlüsse</i>	I_N	<i>Bestell-Nr. Standard</i>	<i>Bestell-Nr. Mit Si.-Überwachung</i>	<i>Drehmom. Gehäuse</i>	<i>Drehmom. Anschl.</i>	<i>VE</i>
Base plate mounting/Aufbaumontage							
TPS 00/250	M8	250 A	33107.0250	33107.0252	5 Nm	14 Nm	2
TPS 00/600	M12	600 A	33107.0600	33107.0602	5 Nm	40 Nm	2
TPS 2/1200	M16	1.200 A	33460.0000	33460.0010	14 Nm	56 Nm	1
TPS 2/1600	2xM12	1.600 A	33560.0000	33560.0010	14 Nm	40 Nm	1
Busbar mounting/Sammelschienenmontage							
TPS 00/250	M8	250 A	33111.0250	33111.0252	14 Nm/6 Nm*	14 Nm	2
TPS 00/600	M12	600 A	33111.0600	33111.0602	40 Nm/15 Nm*	40 Nm	2

* By using contact hook/Bei Verwendung von Kontakthaken

Accessories/Zubehör

Type		Type	Order-No.	Pack
<i>Bezeichnung</i>		<i>Ausführung</i>	<i>Bestell-Nr.</i>	<i>VE</i>
Contact hook for busbar without drilling <i>Kontakt-Haken für Sammelschiene ohne Bohrung</i>		TPS 00/250 TPS 00/600	36571.0010 36890.0010	1
Twinning set for parallel operation of 2 TPS Isolators <i>Verbindungsblende zur gleichzeitigen Betätigung von 2 TPS Trennern</i>		TPS 00/250 TPS 00/600 TPS 2/1200 TPS 2/1600	31187.0100 31187.0100 45071.0100 45071.0100	1 1 3 3
Terminal cover/Anschlussraumabdeckung		TPS 2/1200 TPS 2/1600	31319.0200	1
Micro switch for position indication <i>Mikroschalter zur Schaltstellungsanzeige</i>		TPS 00/250 TPS 00/600 TPS 2/1200 TPS 2/1600	36107.0010 36107.0010 36887.0010 36887.0010	1 1 1 1
Contact for electronic fuse monitoring: Tabs for flat connectors 6,3 mm <i>Anschluss für elektronische Sicherungsüberwachung: Steckzungen für Flachstecker 6,3 mm</i>		TPS 00/250	36325.0010	10



DC	80 V	250 A
		

1.3 Fuse-Bases

TPS Fault Terminator Fuse-Links are useful in Fuse-Bases alternative to TPS Fuse-Isolators. This is possible, if no condition of disconnection is needed and comfortable handling of the TPS Fuse-Isolators is not necessary.

Types

- => Base plate mounting
see product photo (left)
- => Supporting rails mounting

1.3 Sicherungs-Unterteile

TPS Fault Terminator Sicherungseinsätze lassen sich alternativ zu TPS Sicherungs-Trennern in Sicherungs-Unterteilen einsetzen. Dies ist möglich, wenn keine Trenneigenschaften benötigt werden und auf die komfortable Handhabung mit dem TPS Sicherungs-Trenner verzichtet werden kann.

Ausführungen

- => Aufbaumontage
siehe Produktfoto (links)
- => Tragschienenmontage



- => Busbar mounting
- Contact hook

- => Sammelschienenmontage
- Haken



- => Fuse monitoring (accessory)

- => Sicherungsüberwachung (Zubehör)



Type	Terminals	TPS Fault Terminator	Order-No. Standard	Torque Housing	Torque Terminals	Pack
<i>Ausführung</i>	<i>Anschlüsse</i>	I_N	<i>Bestell-Nr. Standard</i>	<i>Drehmom. Gehäuse</i>	<i>Drehmom. Anschl.</i>	<i>VE</i>
Base plate mounting/Aufbaumontage						
00/250	M8	250 A	33120.0010	5 Nm	14 Nm	10
For supporting rails/Für Tragschienen						
00/250	M8	250 A	33120.0070	5 Nm	14 Nm	10
Busbar mounting/Sammelschienenmontage						
00/250	M8	250 A	33003.0020	6 Nm	14 Nm	10

Accessories/Zubehör

Type	Type	Order-No.	Pack
<i>Bezeichnung</i>	<i>Ausführung</i>	<i>Bestell-Nr.</i>	<i>VE</i>
Contact cover with micro switch for fuse monitoring <i>Kontaktabdeckung mit Mikroschalter für Sicherheitsüberwachung</i>	33120.0010 33120.0070	36889.0010	1

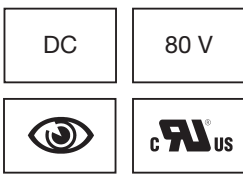
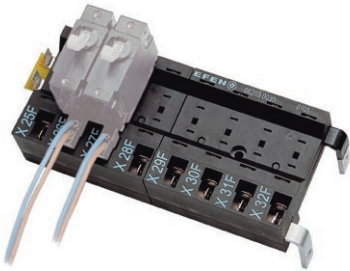

2 Supply bus module

Application

The EFEN supply bus module is used in DC-distributions of fixed line telecommunication systems (i.e. EWSD, DSL) or base stations for mobile communication systems (GSM, UMTS).

It is also suitable for ship and caravan installation.

Additional applications may be found in various DC power distributions.

The EFEN supply bus module is the base for circuit-breakers to protect the outgoing lines.

2.1 Product description

Supply bus module are characterized by:

- Fast and easy push in mounting of circuit breakers
- Long term reliable connection by spring-loaded double-flat contacts
- Two sets of outgoing terminals per breaker

2 Stromverteilermodul

Anwendung

Anwendung findet das EFEN Stromverteilermodul in DC-Verteilungen von Telekommunikationsanlagen im Festnetz (z.B. EWSD, DSL) oder in Basisstationen im Mobilfunk (GSM, UMTS). Ebenso ist es einsetzbar im Schiffsbau und bei Campingfahrzeugen.

Darüber hinaus ist der Einsatz in anderen DC-Verteilungen möglich.

Das EFEN Stromverteilermodul dient zur Kontaktierung von Schutzschaltern der führenden Hersteller.

2.1 Produktbeschreibung

Das Stromverteilermodul zeichnet sich aus durch:

- Schnelle, einfache Aneinanderreihung von Schutzschaltern
- Langlebige, sichere Kontaktierung durch Doppelflachkontakte
- Flexibilität durch zwei Abgänge pro Stromkreis

Technical Data	Main switch circuits-characteristic values	Auxiliary switch circuit-characteristic values
Technische Daten	Hauptstromkreis-Kennwerte	Hilfstromkreis-Kennwerte
Rated operational voltage <i>Bemessungsbetriebsspannung</i>	80 V DC	80 V DC
Summary current supply <i>Summenstrom Verteiler</i>	100 A/150 A	-
Short-circuit current <i>Kurzschlußstrom</i>	3000 A/30 ms	-
Rated current per fitted space <i>Bemessungsnennstrom pro Einbauplatz</i>	25 A	1 A

Pole	Terminals left	Terminals right	Without control circuit
Pole	Anschlüsse links	Anschlüsse rechts	Ohne Hilfsstromkreis
100 A Summary current main circuit/100 A Gesamtstrom Hauptstromkreis			
4	66200.0030	66201.0030	On demand Auf Anfrage
8	66202.0030	66203.0030	
12	66204.0030	66205.0030	
16	66206.0030	66207.0030	
150 A Summary current main circuit/150 A Gesamtstrom Hauptstromkreis			
On demand/Auf Anfrage			

3 Drawings/Maßbilder

TPS Fault Terminator

TPS 00/60-600 A

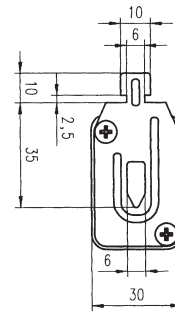
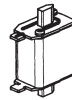
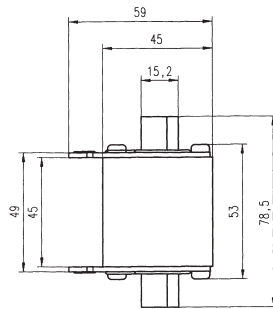

TPS 00/60-600 A with striker/mit Schlagmelder

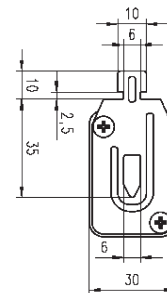
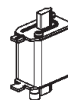
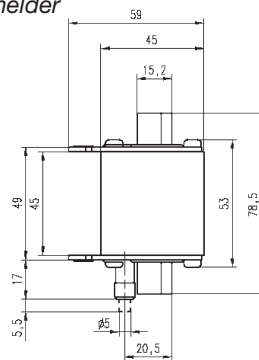
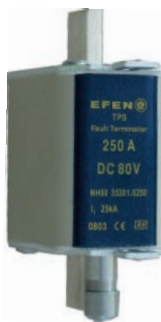

TPS 2/800-1.600 A

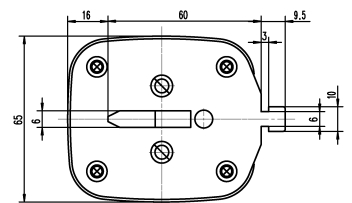
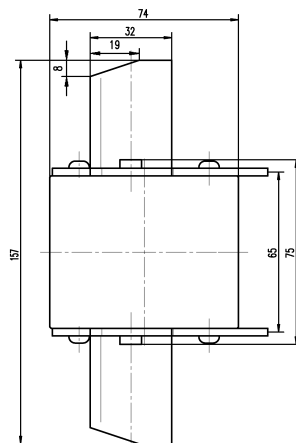

TPS Fuse-Isolator/Sicherungs-Trenner

TPS 00/250

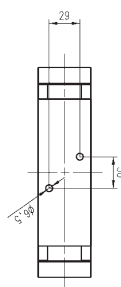

Base plate mounting
Aufbaumontage

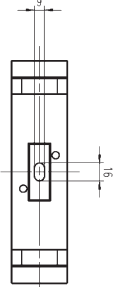

Busbar mounting
Sammelschienenmontage

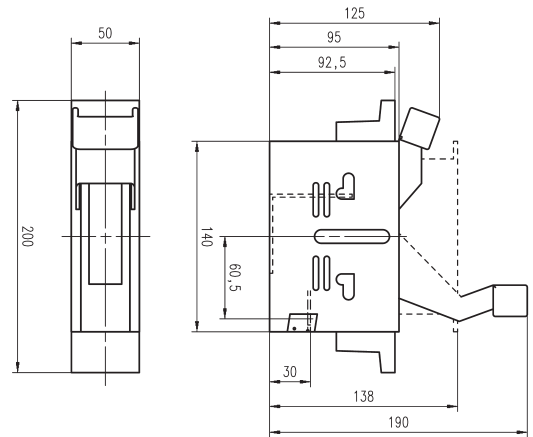

TPS 00/600

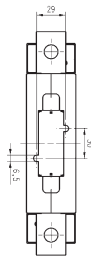

Base plate mounting
Aufbaumontage

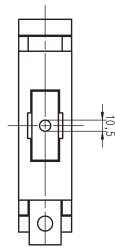

Busbar mounting
Sammelschienenmontage

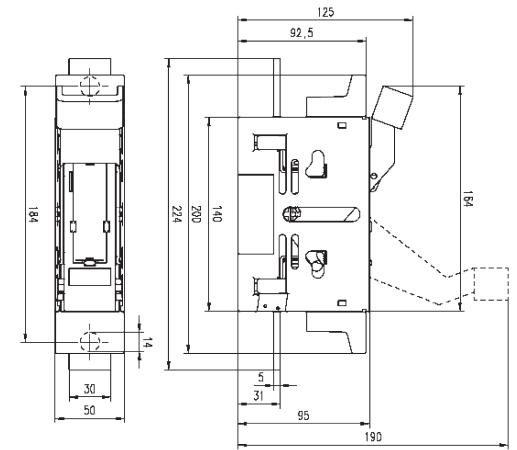

TPS 2/1200



Base plate mounting
Aufbaumontage

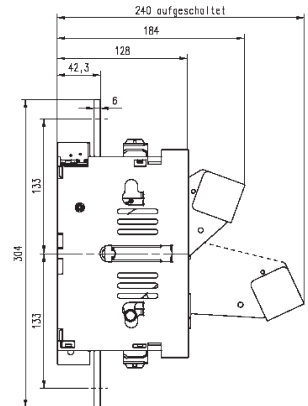
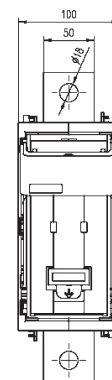
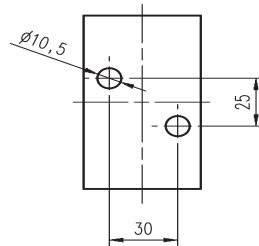

TPS 2/1600



Base plate mounting
Aufbaumontage

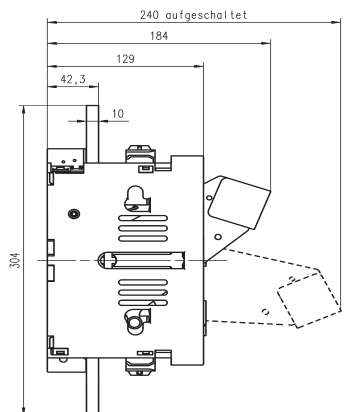
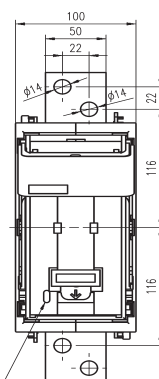
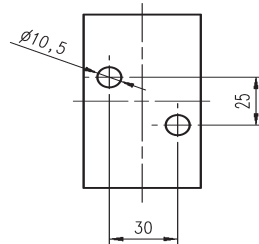

Kabeldurchführung für Sicherungsüberwachung Variante 33560,0010

Fuse-Bases/Sicherungs-Unterteile

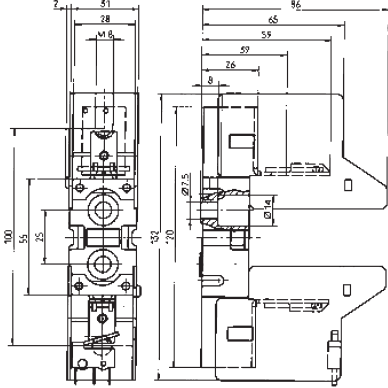

Base plate mounting
Aufbaumontage

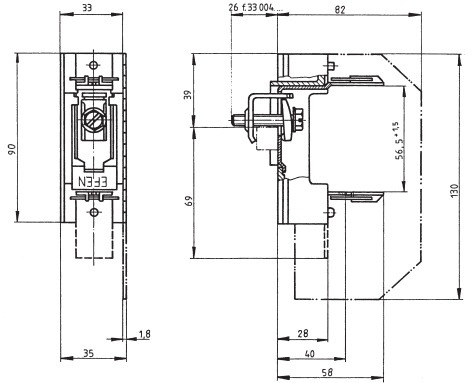

Busbar mounting
Sammelschienenmontage

Supply bus module/Stromverteilermodul

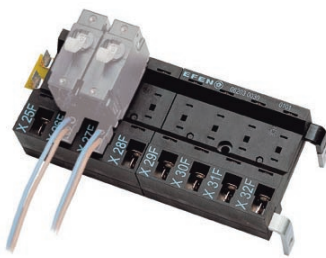

Trough hole for screw M4 / Loch für Zylinderschraube M4

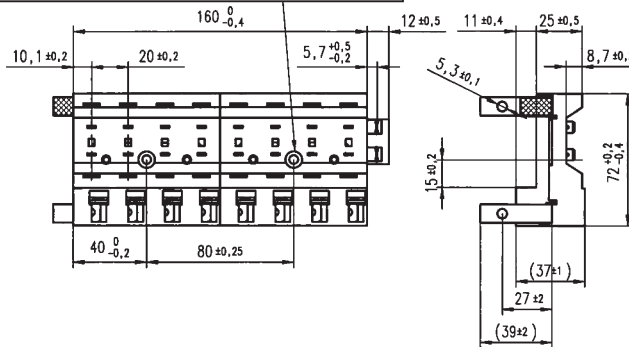

Length	
Längenmaß	
4 pol.	80 mm
8 pol.	160 mm
12 pol.	240 mm
16 pol.	320 mm
18 pol.	400 mm
20 pol.	480 mm

Breaker plug connector
Schutzschalter Stecker

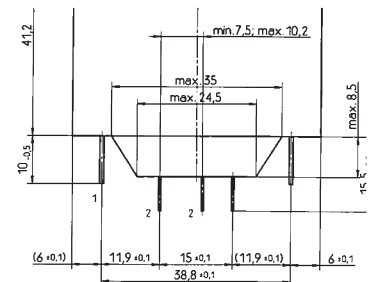
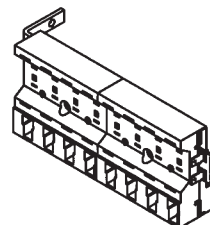
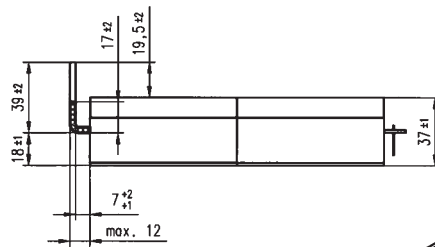

1 Faston-Messer 6,3 nach IEC 61210
2 Faston-Messer 2,8/0,5 nach IEC 61210

N	NH Fuse-Links <i>NH-Sicherungs-Einsätze</i>	
NU	NH Fuse-Bases <i>NH-Sicherungs-Unterteile</i>	
LT	Load Break Switches/Switch-Fuses <i>Lasttrennschalter mit/ohne Sicherungen</i>	
LU	Changeover Switches <i>Lastumschalter</i>	
NT	NH Fuse-Switches – horizontal design <i>NH-Sicherungs-Lasttrenner</i>	
NSL	NH Fuse-Switches – vertical design <i>NH-Sicherungs-Lastschaltleisten</i>	
NL	NH Fuse-Rails – vertical design <i>NH-Sicherungs-Verteilerleisten</i>	
NZ	Accessories <i>Zubehör</i>	
NW	Low Voltage Current Transformers <i>Niederspannungs-Stromwandler</i>	
NA	Low Voltage Surge-Arresters <i>Überspannungs-Ableiter für Niederspannung</i>	
HH	HV Fuse-Links and -Bases <i>Hochspannungs-Hochleistungs-Sicherungen und -Träger</i>	
T	Telecom Power Supply Products <i>Produkte für Telekom Stromversorgung</i>	
S/D	Special Systems/D-System Fuse-Links and -Bases <i>Spezialsysteme/D-Sicherungs-System</i>	